

# AT3216 Series

## Multilayer Chip Antenna

### Features

- ❖ Monolithic SMD with small, low-profile and light-weight type.
- ❖ RoHS compliant



### Applications

- ❖ 6~8.24GHz wireless communication system

### Specifications

Part Number	Operating frequency (MHz)	Peak Gain (XZ-Total)	Average Gain (XZ-Total)	VSWR	Impedance
<b>AT3216-A7R0HAA</b>	6200~8240	2.0 dBi typ.	-0.5 dBi typ.	2 max.	50 Ω

Q'ty/Reel (pcs) : 3,000 pcs  
 Operating Temperature Range : -40 ~ +85 °C  
 Storage Temperature Range : -40 ~ +85 °C  
 Storage Period : 12 months max.  
 Power Capacity : 3W max.

### Part Number

AT   3216   -   A   7R0   HAA   □   □  
 ①   ②   ③   ④   ⑤   ⑥   ⑦

① Type	AT : Antenna	② Dimensions ( L x W )	3.2x 1.6 mm
③ Material Code	A	④ Frequency Range	7R0=7000MHz
⑤ Specification Code	HAA	⑥ Packaging	T: Tape & Reel B: Bulk
⑦ Soldering	/LF=lead-free		

### Terminal Configuration

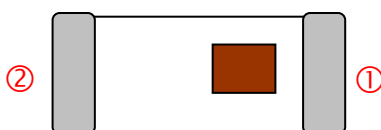

No.	Terminal Name	No.	Terminal Name
①	Feeding Point	②	NC

**Dimensions and Recommended PC Board Pattern**

Unit : mm

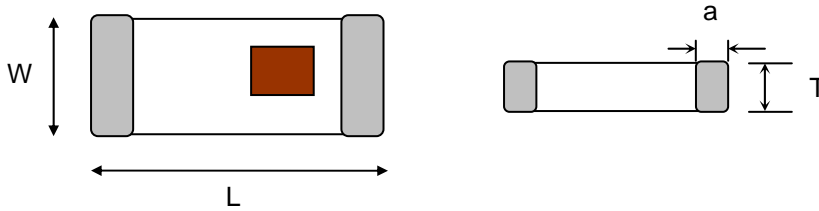

Mark	L	W	T	a
Dimensions	3.2±0.2	1.6±0.2	1.3+0.1 /-0.2	0.5±0.3

❖ With Matching Circuits

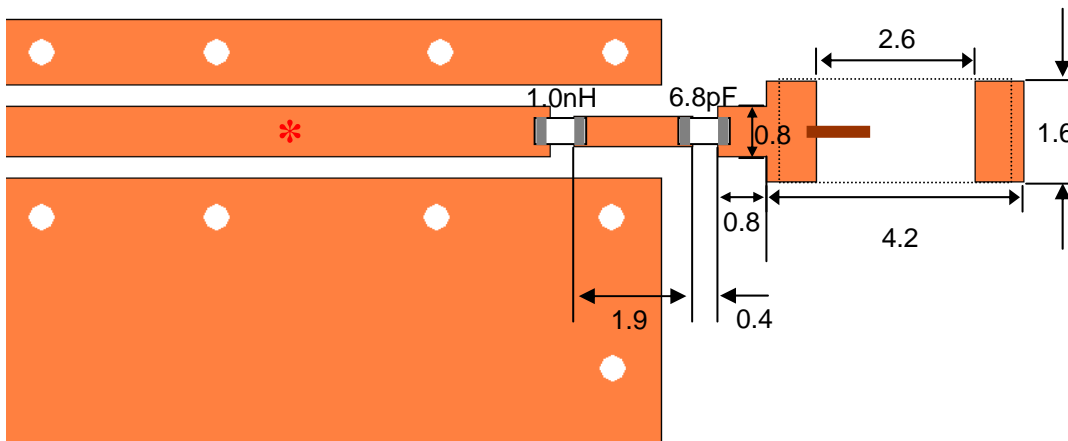

\*Line width should be designed to match 50Ω characteristic impedance, depending on PCB material and thickness.

Typical Electrical Characteristics (T=25°C)

❖ Test Board

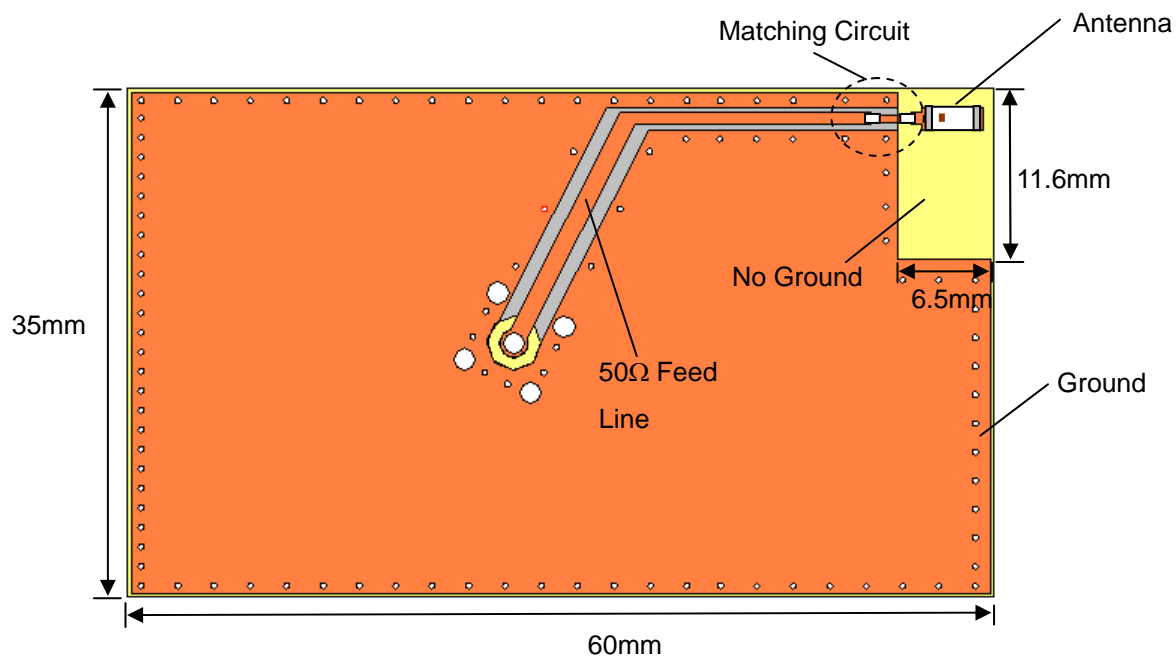

❖ Return Loss

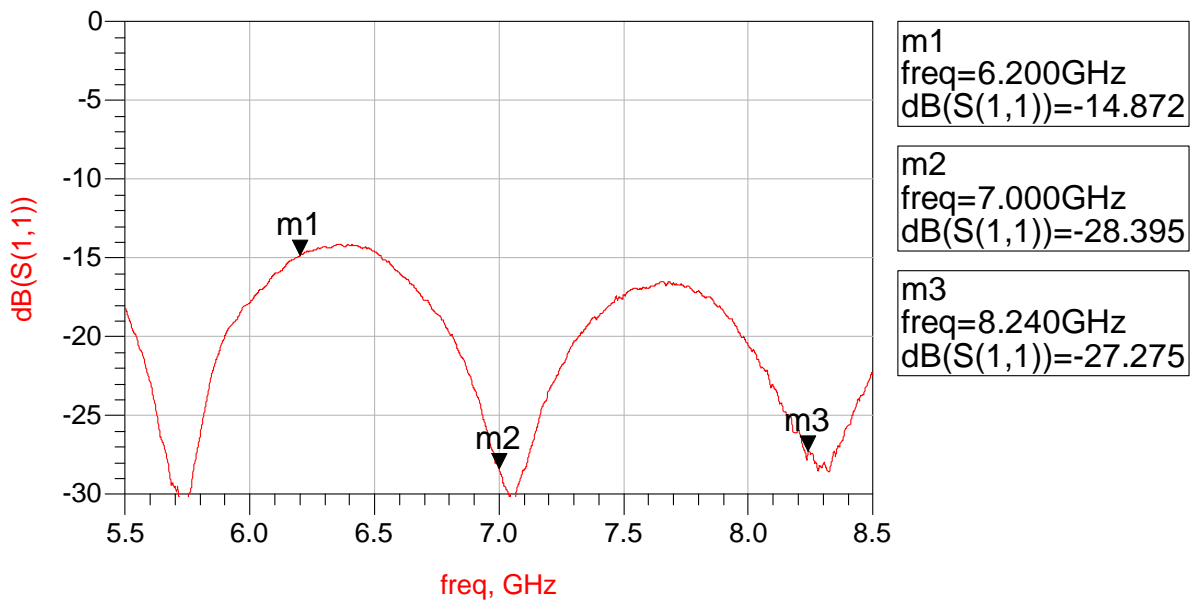

❖ Radiation Patterns @ 7000MHz

(Antenna Efficiency: 6200 / 7000 / 8240MHz : 63 / 82 / 68%)

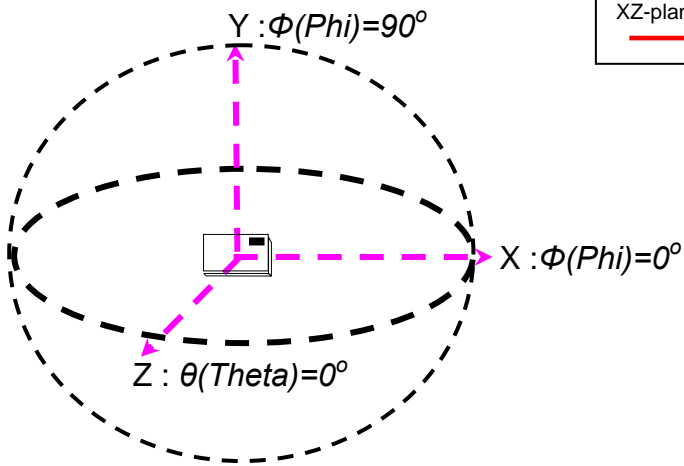

XZ-plane @7000MHz  
— Total

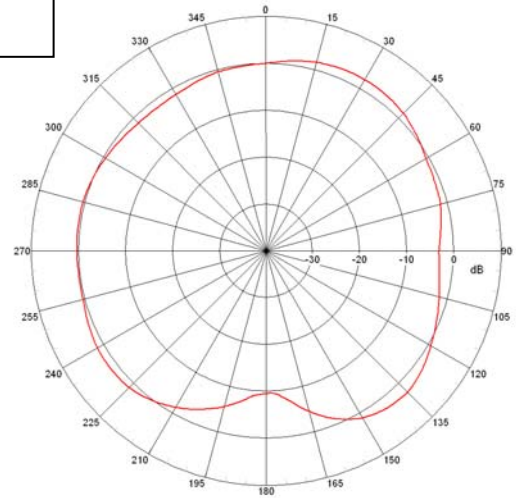

YZ-plane @7000MHz  
— Total

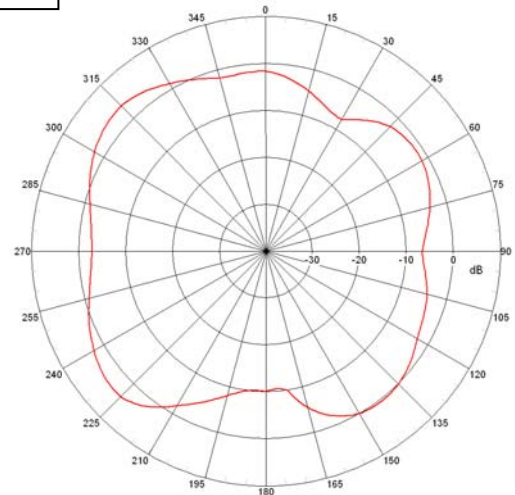

XY-plane @7000MHz  
— Total

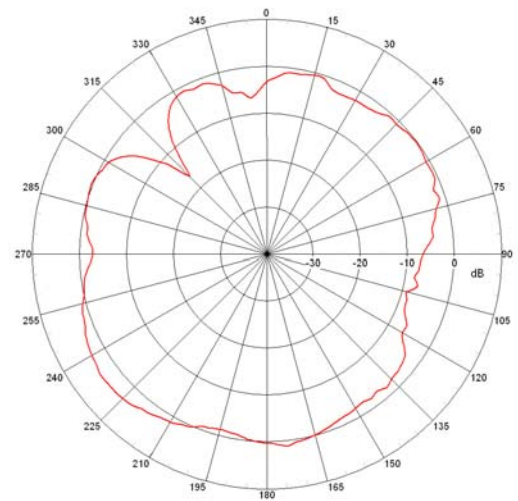

## Taping Specifications

### ❖Tape & Reel Dimensions (Unit: mm) vs. Quantity (pcs)

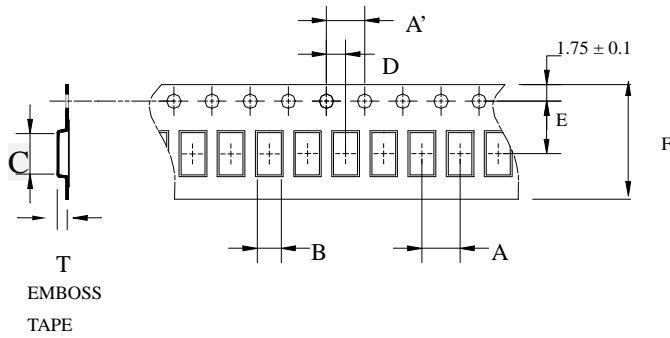

Type	A	A'	B	C	D	E	F	T	Quantity/per reel	Tape material
AT3216	4.0±	4.0±	1.88±	3.5±	2.0±	3.5±	8.00±	1.27±	3,000pcs	Plastic (Embossed)
	0.1	0.05	0.1	0.1	0.05	0.05	0.1	0.1		

### ❖Reel Dimensions (Unit: mm)

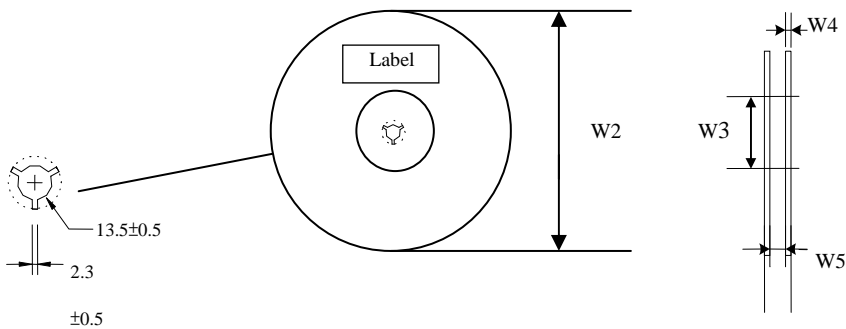

Label: Customer's Name,  
ACX P/N, Q'ty, Date,  
ACX Corp.

Type	W2	W3	W4	W5
AT3216	178±1	60±1	1.4±0.2	9.0±0.3

### ❖Leader and Trailer Tape

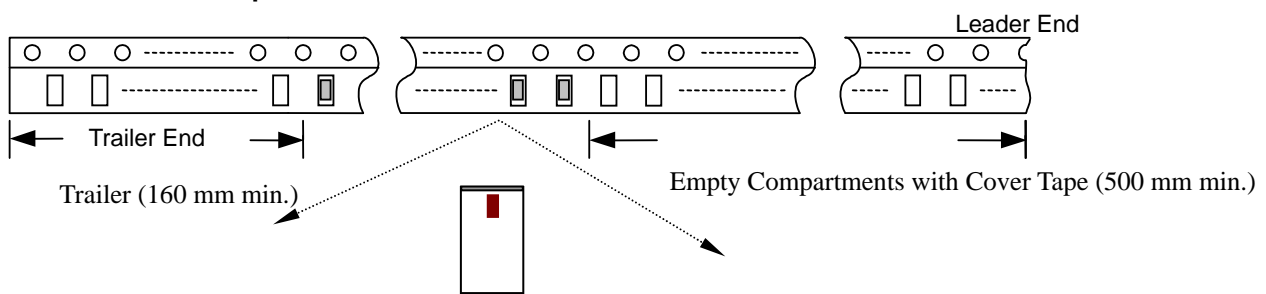

❖ **Peel-off Force**

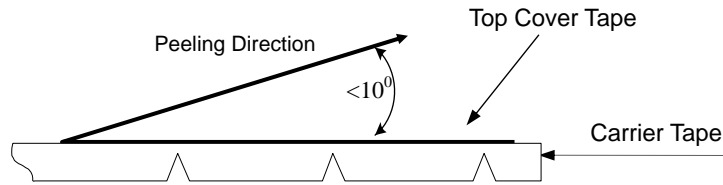

Peel-off force should be in the range of 0.1 – 0.6 N at a peel-off speed of  $300 \pm 10$  mm/min .

❖ **Storage Conditions**

- (1) Temperature: 5 ~35°C , relative humidity (RH): 45~75%.
- (2) Non-corrosive environment

**Notes**

❖ The contents of this data sheet are subject to change without notice. Please confirm the specifications and delivery conditions when placing your order.

**Mechanical & Environmental Characteristics**

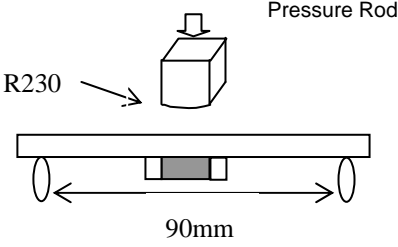
Item	Requirements	Procedure
Solderability	<ol style="list-style-type: none"> <li>No apparent damage</li> <li>More than 95% of the terminal electrode shall be covered with new solder</li> </ol>	<ol style="list-style-type: none"> <li>Preheat: <math>120 \pm 5^\circ\text{C}</math></li> <li>Solder: <math>245 \pm 5^\circ\text{C}</math> for <math>5 \pm 1</math> sec</li> </ol>
Soldering strength (Termination Adhesion)	<ol style="list-style-type: none"> <li>10N minimum</li> </ol>	<ol style="list-style-type: none"> <li>Solder specimen onto test jig.</li> <li>Apply push force at 0.5mm/s until electrode pads are peeled off or ceramic are broken. Pushing force is applied to longitude direction</li> </ol>
Deflection (Substrate Bending)	<ol style="list-style-type: none"> <li>No apparent damage</li> <li>Fulfill the electrical specification</li> </ol>	<ol style="list-style-type: none"> <li>Solder specimen onto test jig (FR4, 1.6mm) using the recommend soldering profile.</li> <li>Apply a bending force of 2mm deflection</li> </ol> 
Heat/Humidity Resistance	<ol style="list-style-type: none"> <li>No apparent damage</li> <li>Fulfill the electrical specification after test</li> </ol>	<ol style="list-style-type: none"> <li>Temperature: <math>85 \pm 2^\circ\text{C}</math></li> <li>Humidity: 90% ~ 95% RH</li> <li>Duration: <math>1000 \pm 48</math>hrs</li> <li>Recovery: 1-2hrs</li> </ol>
Thermal shock (Temperature Cycle)	<ol style="list-style-type: none"> <li>No apparent damage</li> <li>Fulfill the electrical specification after test</li> </ol>	<ol style="list-style-type: none"> <li>One cycle/step 1 : <math>125 \pm 5^\circ\text{C}</math> for 30 min step 2 : <math>-40 \pm 5^\circ\text{C}</math> for 30 min</li> <li>No of cycles : 100</li> <li>Recovery: 1-2 hrs</li> </ol>
Low Temperature Resistance	<ol style="list-style-type: none"> <li>No apparent damage</li> <li>Fulfill the electrical specification after test</li> </ol>	<ol style="list-style-type: none"> <li>Temperature: <math>-40 \pm 5^\circ\text{C}</math></li> <li>Duration: <math>500 \pm 24</math>hrs</li> <li>Recovery: 1-2hrs</li> </ol>

## Soldering Conditions

### ❖ Typical Soldering Profile for Lead-free Process

Reflow Soldering :

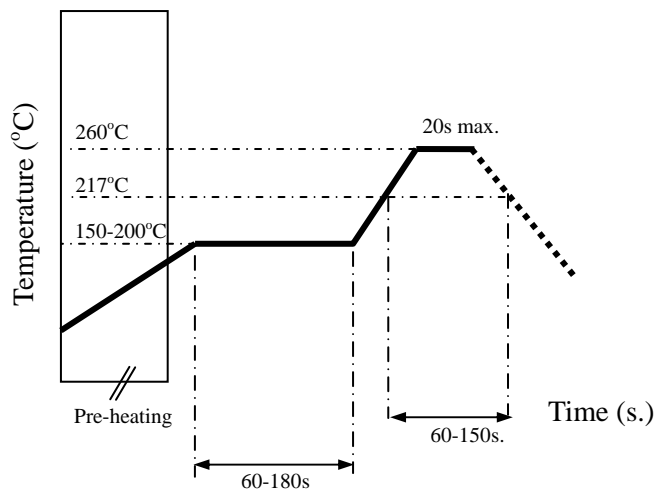

## Notes

❖ The contents of this data sheet are subject to change without notice. Please confirm the specifications and delivery conditions when placing your order.

### **Advanced Ceramic X Corp.**

16 Tzu Chiang Road, Hsinchu Industrial District Hsinchu Hsien 303, Taiwan

TEL:886-3-5987008 FAX:886-3-5987001

E-mail: [acx@acxc.com.tw](mailto:acx@acxc.com.tw)

<http://www.acxc.com.tw>